

WEG010032A OLED Graphic 100x32 dots

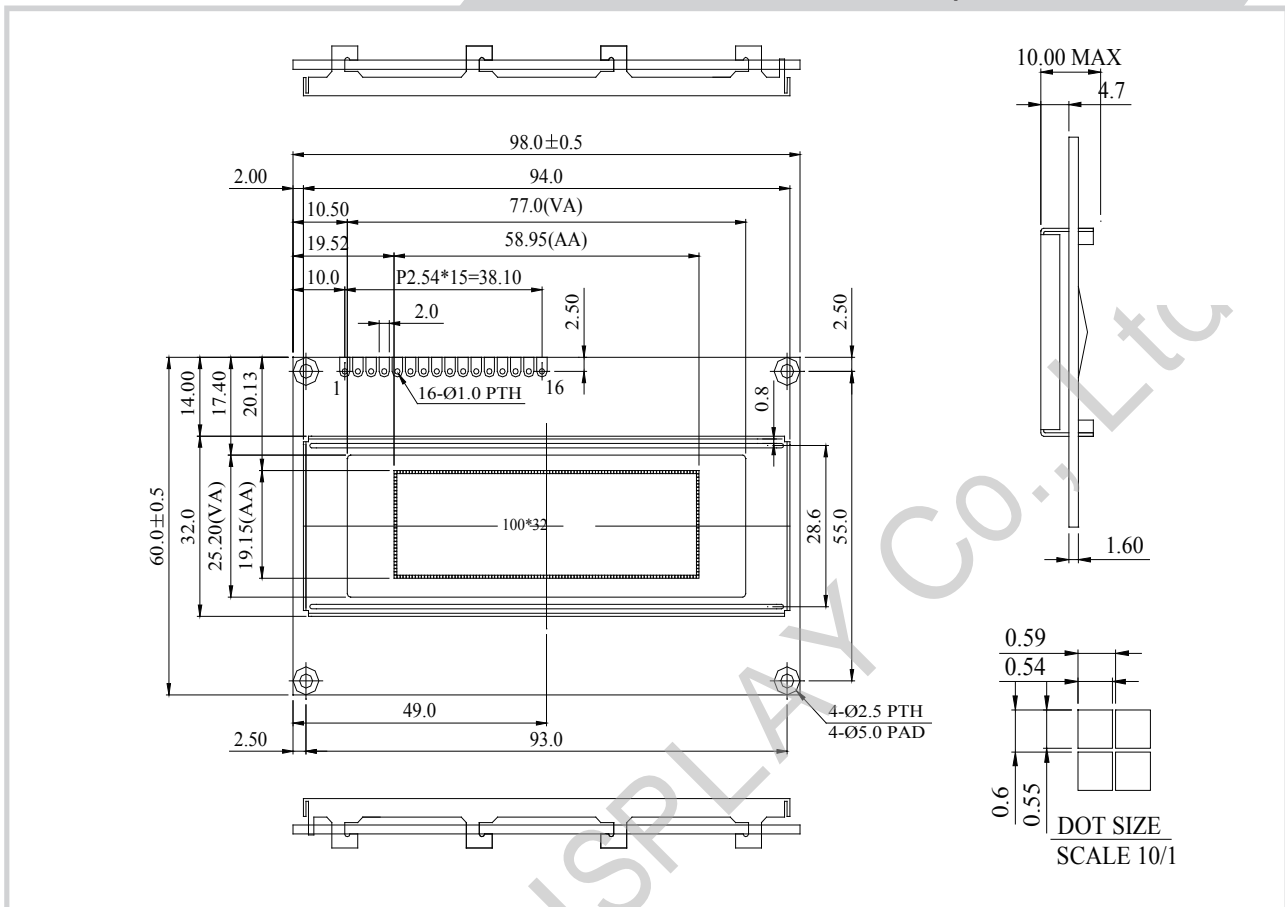

Feature

1. 100*32 Dot Matrix
2. Built-in Controller WS0010
3. +5V power supply
4. 1/16 duty cycle
5. Interface: 6800, option 8080, SPI
6. Polarizer optional

Pin No.	Symbol	Description
1	VSS	Ground Pin
2	VDD	Voltage for logic
3	NC	No Connection
4	RS	Register Select
5	R/W	Read/Write Control
6	E	Chip Enable Signal
7	DB0	Data Bus
8	DB1	Data Bus
9	DB2	Data Bus
10	DB3	Data Bus
11	DB4	Data Bus
12	DB5	Data Bus
13	DB6	Data Bus
14	DB7	Data Bus
15	NC	No Connection
16	NC	No Connection

Mechanical Data

Item	Standard Value	Unit
Module Dimension	98.0 x 60.0	mm
Viewing Area	77.0 x 25.2	mm
Active Area	58.95 x 19.15	mm
Dot Pitch	0.59 x 0.60	mm
Dot Size	0.54 x 0.55	mm

Electrical Characteristics

Item	Symbol	Condition	Standard Value			Unit
			min.	typ.	max.	
Input Voltage	VDD	---	4.8	5.0	5.3	V