

# 承認申請書

## ROHS COMPLIANCE

客戶名稱:  
Customer  
廠商料號: MERFA-25-W17-B-24005875  
Part No.  
品名: Dual Band  
Description  
圖號: MERFA-25-W17-B-24005875  
Drawing No.  
客戶料號:  
Drawing No.

出廠簽章:

檢 查 TEST BY	核 對 CHECK BY	承 認 APPROVE BY

承認簽章:

檢 查 TEST BY	核 對 CHECK BY	承 認 APPROVE BY

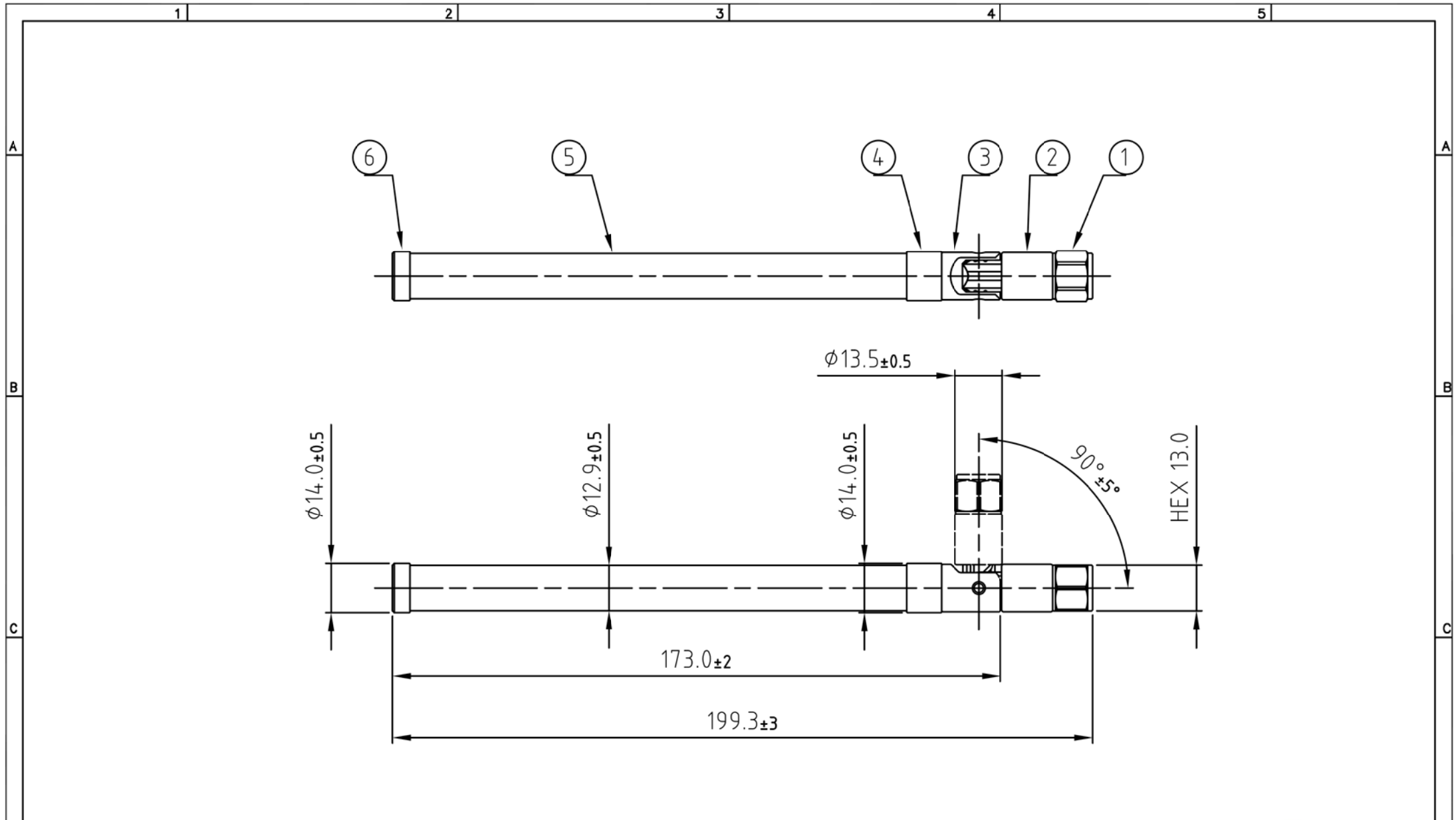

NO.	NAME	FINSH	MAT'L	Q'TY	MEMO
1.	Connector	Ni Plated	Brass	1	SMA PLUG
2.	Hinge	Black	PC	1	
3.	Base	Black	PC	1	
4.	Tube	Ni Plated	Brass	1	
5.	Antenna Tube	Black	Fiber Glass	1	
6.	Cap	Ni Plated	Brass	1	

PROJECTION		TOLERANCE UNLESS OTHERWISE SPECIFIED	
		LINER	ANGLE
UNITS		.X ±1	X° ±5°
mm		.XX ±0.5	
		.XXX ±0.2	
REV.	A	APPD.	
SHEET	1/1	CHKD.	
SIZE	A4	DESIGN	
SCALE	1:1.5	DRAW	VINCE
			2019/12/11

**MAP electronics co., Ltd.**  
Material All Procurement

TITLE  
MERFA-25-W17-B-24005875

DWG NO.  
MERFA-25-W17-B-24005875

# Waterproof Antenna

## MERFA-25-W17-B-24005875

### Specifications

Frequency	2400-2500 MHz	5150-5875 MHz
Peak Gain	3.3 dBi	5 dBi
Average gain	1.43 dBi	1.6 dBi
VSWR	2.0 : 1 Max.	2.0 : 1 Max.
Polarization	Linear, vertical	
Impedance	50 Ω	
Self Waterproof	IPX7	

### Mechanical Properties

Connector	SMA PLUG
Durability(mating)	500 cycles
Pull-out force	4kgf
Torque	≥0.6kgf-cm
Swivel Angle	0° / 45° / 90°
Radome Material (UL)	Glass fiber

### Environment & Mechanical Characteristics

Operating Temperature	- 40°C to +85°C
Storage Temperature	- 40°C to +85°C
Humidity	95% @ 25°C

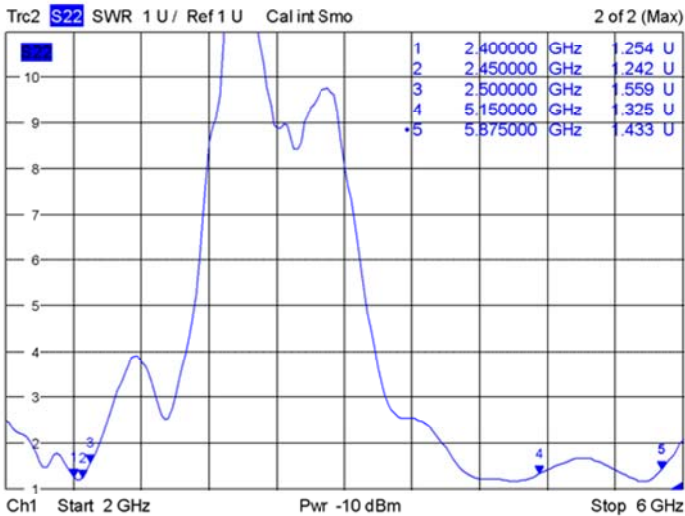
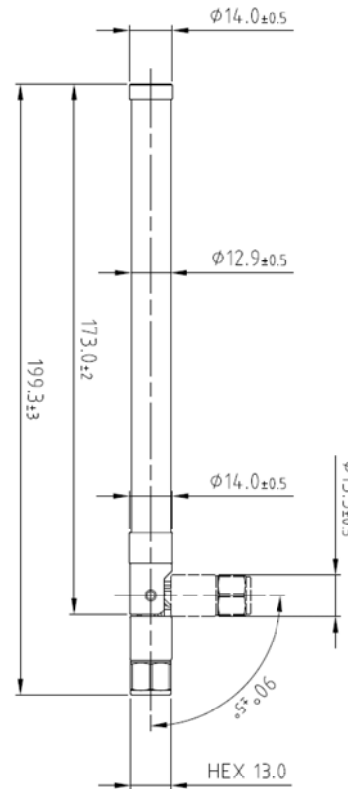

Date: 26.NOV.2019 13:28:56

# Radiation Pattern

2G Band = 2400 - 2500 MHz % 2G Band

XY Plane (+X = 0°, +Y = +90°) / Elevation = 90 °

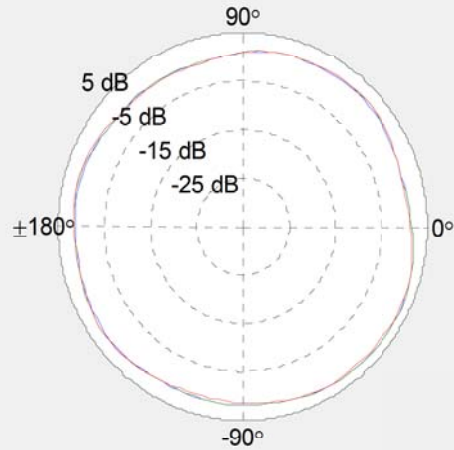

ZX Plane (+Z = 0°, +X = +90°) / Azimuth = 0 °

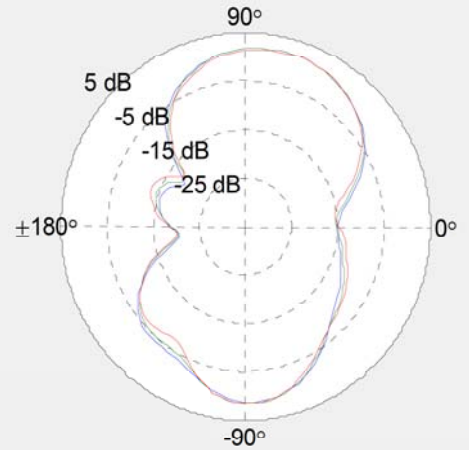

YZ Plane (+Z = 0°, +Y = +90°) / Azimuth = 90 °

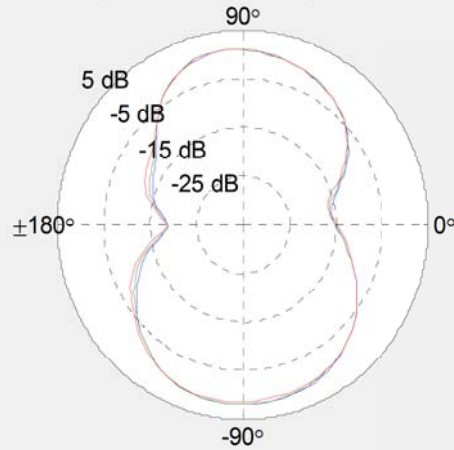

# Radiation Pattern

5G Band = 4400 - 6000 MHz

XY Plane (+X = 0°, +Y = +90°) / Elevation = 90 °

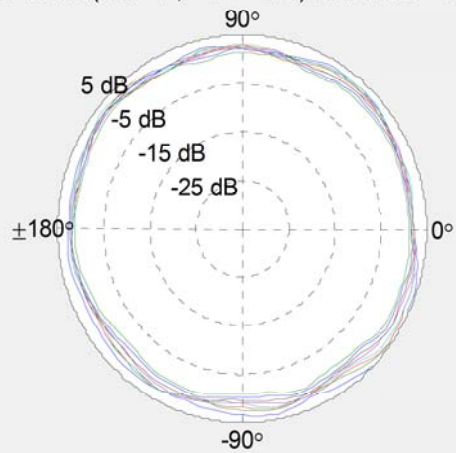

ZX Plane (+Z = 0°, +X = +90°) / Azimuth = 0 °

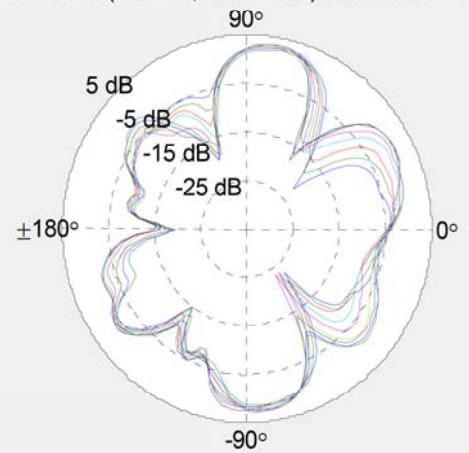

YZ Plane (+Z = 0°, +Y = +90°) / Azimuth = 90 °

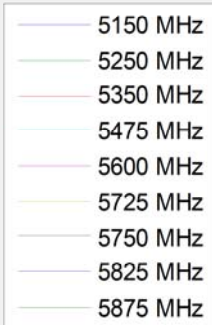
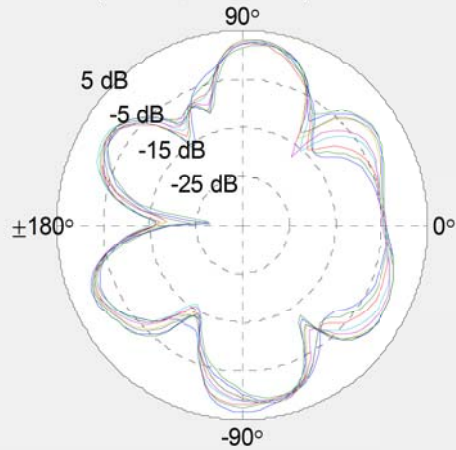

## Gain Table

Frequency (MHz)	V+H Avg. Gain	V+H Peak Gain
	XY-plane	XY-plane
2400.00	1.40	3.18
2450.00	1.52	3.30
2500.00	1.36	3.04
5150.00	2.53	5.11
5250.00	1.93	4.36
5350.00	1.70	4.28
5475.00	1.91	3.74
5600.00	1.56	3.31
5725.00	1.44	3.55
5750.00	1.47	3.42
5825.00	0.89	2.83
5875.00	0.91	2.31

Test report

3D

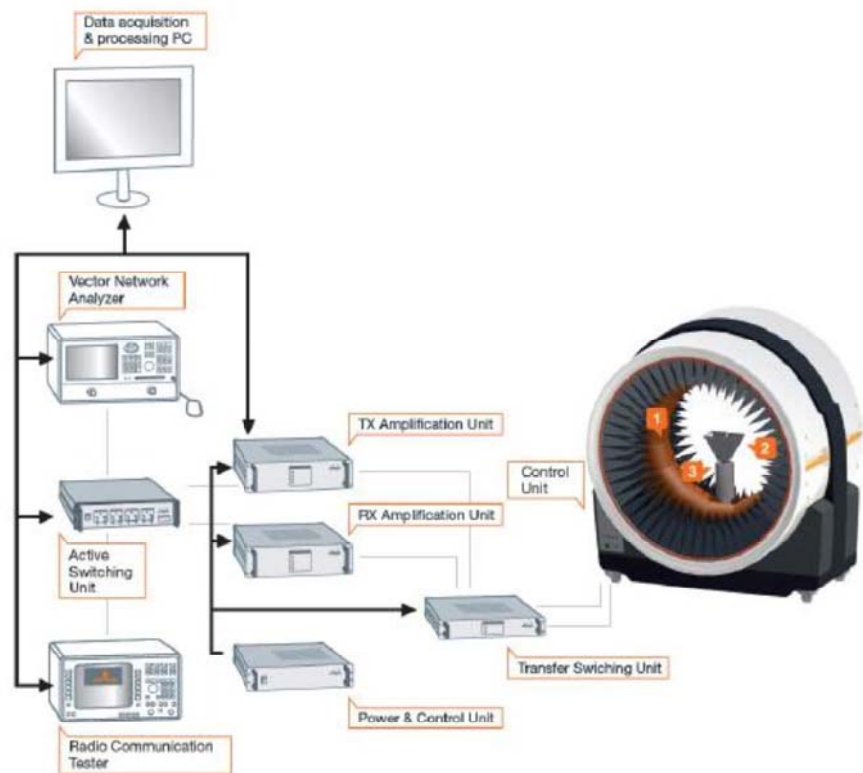

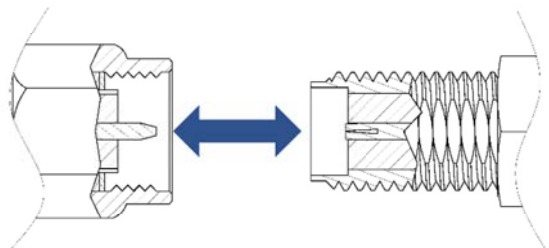
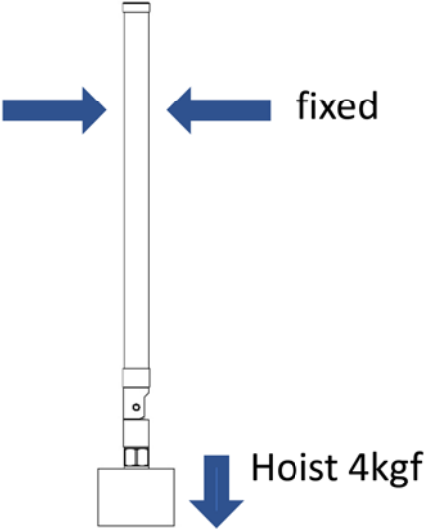
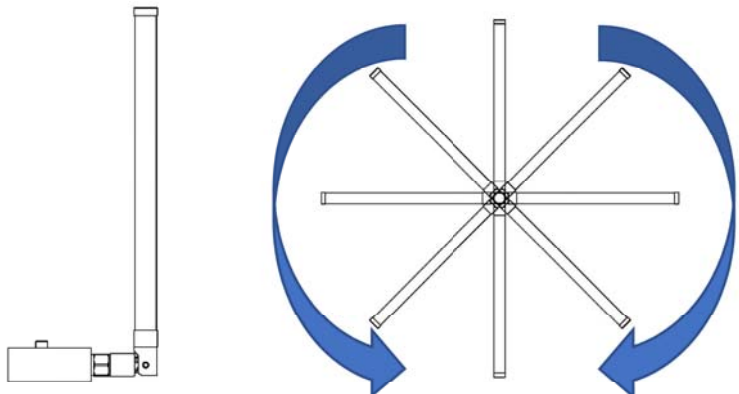
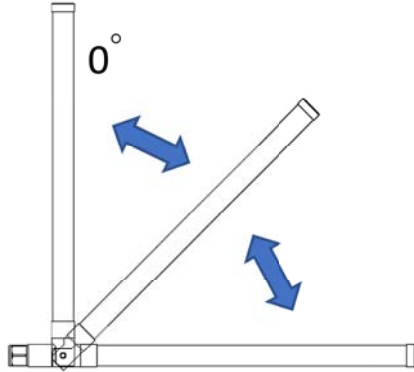
Mechanical Properties		
Mechanical Requirements		Schematic diagram
Durability	500 cycles	
Pull-out force	4Kgf	
Torque	$\geq 0.6\text{kgf-cm}$ Antenna can be Rotated any angle Does not fall	
Swivel Angle	$0^\circ/45^\circ/90^\circ$	

# SPECIFICATION FOR APPROVAL

DOCUMENT: A30178B007

---

STYLE : RG-178B/U

---

SIZE: 7/0.102 SCCS

---

RECOGNIZED: UL 1979

---



STYLE	105°C 30V UL1979	DOCUMENT NO : A30178B007	
SIZE	RG-178B/U	ESTABLISHED DATE: 2008/11/18	
STANDARD : MIL-C-17			
Conductor	Size	AWG	30
	Material	----	Silver-Coated Copper Clad Steel
	Conductors No.	----	7
	Conductors Size	mm	0.102
	O.D.	mm	0.31
Insulation	Average Thickness	mm	0.28
	Diameter	mm	0.86 ±0.03
	Material	----	FEP
	Color	----	Clear
Braid	Material	----	Tinned Copper
	Construction	mm	16 / 3 / 0.1
	Coverage	%	95.3
Jacket	Average Thickness	mm	0.25
	Diameter	mm	1.80 ±0.05
	Material	----	FEP
	Color	----	ACCORDING TO CUSTOM
Marking	Non		
Drawing			

AK001/210X297/1.0

PAGE : 1

EDITION : 1.3

MAKER : *H. C. KUO*

CONFIRM : *C. Y. Chen*

APPROVAL : *W. J. Wang*

Electrical & Physical Properties					
Item		RG-178B/U			
Rating Temperature		105°C 30V			
Conductor Resistance		838 OHM/KM/20°C MAX.			
Insulation Resistance		3000 MEGA OHM-KM MIN.			
Dielectric Strength		AC 1.0 KV/Minute			
Spark Test		2.5 KV			
Insulation	Unaged	Tensile Strength	2500 PSI MIN.( 1.76 Kg / m m <sup>2</sup> )		
		Elongation	200% MIN.		
	Aged	Tensile Strength	UNAGED MIN 75%(168HRS×232°C)		
		Elongation	UNAGED MIN 75%(168HRS×232°C)		
Jacket	Unaged	Tensile Strength	2500 PSI MIN.( 1.76 Kg / m m <sup>2</sup> )		
		Elongation	200% MIN.		
	Aged	Tensile Strength	UNAGED MIN.75%(168HRS×232°C)		
		Elongation	UNAGED MIN.75%(168HRS×232°C)		
Nom. Impedance		50±5 Ohms			
Nom. Capacitance		95.8 pF/m			
Nom. Vel. of Prop.		69.5%			
VSWR (0 - 6 GHZ)		Max 1.3			
THERMAL SHOCK		Max 1mm at 232°C/1HR			
BEND RADIUS		Min 9mm			
Attenuation (dB/1m)	1GHz	1.8GHz	2.4GHz	5.2GHz	6GHz
	1.8	2.6	2.9	4.5	4.9

AK001/210X297/1.0

PAGE : 2

EDITION : 1.3

MAKER : *H. C. KUO*

CONFIRM : *C. Y. Chen*

APPROVAL : *W. J. Wang*

文件編號		文件名稱	<b>G042-1_MERFA-25-W17-B-24005875</b>		發行版本	A	頁次	1/1
客戶代號：	G042-1			最小包裝	PCS	1		
客戶料號/品名：				中包裝	PCS	10		
亞驪料號/品名：	MERFA-25-W17-B-24005875			大包裝	PCS	100		
相關配件				備註				

1. 最小包裝(1PCS-單支舒服多包)	2. 中包裝(10PCS-PE 袋)
 <p>示意圖</p>	 <p>示意圖</p>
3. 大包裝(100PCS-1 箱)	
 <p>示意圖</p>	

## ご使用にあたっての特記事項

(ご使用環境について)

1. エンドユーザー様の様々なご使用環境（アンテナ設置場所における電氣的性能、耐久性、耐候性、特有の環境条件、運用方法、取付方法、取扱方法、設置期間など）は、弊社では分かりかねますので、エンドユーザー様ご使用環境に本アンテナご使用が合致するかの試験、ご判断は御社にてお願い申し上げます。

ご使用環境例：

屋内屋外使用・設置周辺素材・雨・雪・振動・風・紫外線・塩害・油・粉塵・ガス・放射線・重量負荷など

(ご使用環境例は記載した内容に限定されるものではありません)

(SMA コネクタカップリングナットについて)

2. 本アンテナは、接続される装置等への SMA コネクタ接続後に、レドーム部（アンテナ部）を回転させて設置角度を変更・保持できる機構が備わっております。本機構のため、SMA コネクタカップリングナットの回転がいわゆる通常の SMA コネクタに比べ固くなっておりますが、ご了承ください。装置等へのコネクタ接続は、カップリングナットを回転させての接続が基本であります。上記機構のため、アンテナ全体を回転させて取付の際は接続コンタクト部分にご注意ください。

(回転機構について)

3. 2. の嵌合接続後のアンテナ回転機構ですが、回転回数制限について、 $360^{\circ}$  移動分を 1 回転分として 50 回転まででお願いいたします。回転機構はアンテナ設置時の角度を調整する用途ですので、回転速度、連続回転運用についてはご配慮下さい。

(可倒機構について)

4. 本アンテナは上記回転機構の他にストレート ( $0^{\circ}$ ) 状態からライトアングル ( $90^{\circ}$ ) 状態、その中間 ( $45^{\circ}$ ) への角度調整が可能となっておりますが、こちらもアンテナ設置時の角度を調整する用途ですので、ご運用時の頻繁な角度変更についてもご配慮下さい。